

Operating Instructions

**vacuum-based lifting device
for glass elements**

OKTOPUS[®] GLASS-Jack GL-LN 600

Serial no.: A 810 664

Technical Documentation

BA 000 247

07/2016

This technical documentation corresponds to the status as per the issue date.

**WIRTH GMBH
INSTALLATION SYSTEMS DIVISION**

Brehnaer Straße 1
D-06188 Landsberg
Phone +49 34 602 / 70 88 - 0
Telefax +49 34 602 / 70 88 - 111
www.wirth-gmbh.com

| | Page |
|--|-----------|
| Table of Contents | 2 |
| 1 General Information on the OKTOPUS® | 4 |
| 1.1 Manufacturer's information | 4 |
| 1.2 Service workshop | 4 |
| 1.3 Scope of application | 4 |
| 2 Proper use of the OKTOPUS® | 5 |
| 2.1 Functional principle and safety concept of the OKTOPUS® system | 5 |
| 2.2 Safety instructions | 6 |
| 2.3 Symbols and markings | 7 |
| 2.4 Structure and use of the OKTOPUS® | 8 |
| 2.4.1 Possible configuration of the OKTOPUS® and arrangement of the suction pads | 9 |
| 2.5 Operating conditions and restrictions | 11 |
| 2.6 Transport and storage | 12 |
| 3 Instructions for using the OKTOPUS® | 13 |
| 3.1 Electrical power supply | 13 |
| 3.2 Vacuum supply | 14 |
| 3.3 Preparation of the OKTOPUS® | 15 |
| 3.3.1 Assembling and disassembling of the extensions | 15 |
| 3.3.2 Modification of suction pads | 16 |
| 3.3.3 Adjustment of the crane eye | 16 |
| 3.4 Control panel / switch | 16 |
| 3.5 Startup | 16 |
| 3.6 Handling of glass and cladding elements | 17 |
| 3.6.1 Handling of lying glass and cladding elements | 17 |
| 3.6.2 Handling of upright glass and cladding elements. | 18 |
| 3.6.3 Rotating vertically hanging loads | 19 |
| 3.6.4 Tilting vertically hanging loads | 19 |
| 4 Service and Maintenance | 21 |
| 4.1 General remarks | 21 |
| 4.2 Mechanical system | 21 |
| 4.3 Vacuum system | 22 |
| 4.3.1 Cleaning the suction pads | 22 |
| 4.4 Electrical and electronic components | 23 |
| 5 Handling incidents | 25 |
| 6 Disposal and recycling | 25 |
| Annex 1: Abstract of Operating Instructions OKTOPUS® GLASS-Jack GL-LN 600 | |
| Annex 2: Functional dimensions | |
| Annex 3: EC Declaration of Conformity | |
| Annex 4: Inspection Tag according to Directive 2006/42/EC | |
| Annex 5: Electrical Circuit Diagram | |

| | Page |
|--|----------|
| Table of figures | 3 |
| Fig. 1: OKTOPUS® GLASS-Jack GL-LN 600 basic device | 8 |
| Fig. 2: Load lifting attachment OKTOPUS® GLASS-Jack GL-LN 600 | 9 |
| Fig. 3: Possible configuration of the OKTOPUS® and arrangement of the suction pads | 10 |
| Fig. 4: Charge indicator | 13 |
| Fig. 5: Vacuum gauge | 14 |
| Fig. 6: Mounting of the extensions (Examples) | 15 |
| Fig. 7: Switch „Suction/Release“ | 16 |
| Fig. 8: OKTOPUS® GLASS-Jack GL-LN 600 with horizontal glass element | 18 |
| Fig. 9: OKTOPUS® GLASS-Jack GL-LN 600 with vertical glass element | 19 |
| Fig. 10: OKTOPUS® GLASS-Jack GL-LN 600 during tilting | 20 |
| Fig. 11: Suction pad | 22 |
| Fig. 12: Battery charger (sample) | 23 |
| Fig. 13: Warning devices | 25 |

1 General Information on the OKTOPUS®

1.1 Manufacturer's information

Manufacturer's name and registered office:

WIRTH GMBH
Division Vacuum Lifting Technology
Brehnaer Straße 1
D-06188 Landsberg

Device characteristics:

| | |
|---|--|
| Product description: | OKTOPUS® GLASS-Jack GL-LN 600 |
| Type: | OKTOPUS® GLASS-Jack GL-LN 600 R M B24 P 110 |
| Serial number: | (see type plate) |
| Year of manufacture: | (see type plate) |
| Weight: | approx. 60 to 95 kg |
| Working Load Limit: | max. 300 kg (4 suction pads Ø300 mm) max. 450 kg (6 suction pads Ø300 mm) max. 600 kg (8 suction pads Ø300 mm) |
| CE mark: | according to EC-Declaration Annex 3 |
| Inspection tag according to Annex 4 attached to the device. | |

1.2 Service workshop

WIRTH GMBH
Brehnaer Str. 1
D-06188 Landsberg
Germany

Phone: +49 (0) 34 602 / 70 88 - 0
Fax no.: +49 (0) 34 602 / 70 88 - 111
E-Mail: info@wirth-gmbh.com

1.3 Scope of application

The operating instructions on hand represent the state-of-the art and the safety measures defined by the European Machinery Directive valid at the editing date of the manual.

Diverging or amending national regulations may not be considered eventually. The user is exclusively responsible to observe such regulations.

2 Proper use of the OKTOPUS®

2.1 Functional principle and safety concept of the OKTOPUS® system

Devices of the OKTOPUS® system are “**load lifting attachments**” operating according to the principle “*vacuum lifter*”. They are mounted to a hoist or operate as a stand-alone unit and are used for handling and positioning large-sized construction elements.

The basic functional principles of the OKTOPUS® system are:

- ⇒ controlled suction and release of large-sized construction elements having sufficient inherent stability using one or more suction pad(s) of the OKTOPUS®,
- ⇒ transport and positioning of the sucked elements by manipulating the OKTOPUS®,
- ⇒ vernier positioning of the elements attached to the OKTOPUS® by controlling the OKTOPUS® axes (if available).

For various fields of application we offer different designs and types of the OKTOPUS®. These differ depending on the used hoist, the loads to be lifted, the required positioning movements and the used controls.

For further information please contact us or visit our website at www.wirth-gmbh.com.

Specific safety requirements, which have been taken into account during construction, execution, technical documentation and in drawing up the operating instructions, result from the function of the OKTOPUS® being a load lifting attachment.

Therefore, strict adherence to the instructions and information for proper and safe use given in the operating manual is a prerequisite for the manufacturer’s warranty during the stipulated warranty period.

Combining the OKTOPUS® with a hoist is the responsibility of the OKTOPUS® user. The user himself is responsible for proper implementation of the relevant guidelines and instructions. The instructions given in this operating manual by the OKTOPUS® manufacturer are considered to be additional support.

Prior to initial startup of the machine the suitability of the combination OKTOPUS®/forklift or crane in operating conditions has to be checked by skilled personnel.

Furthermore, the OKTOPUS® has to undergo regular inspections by an expert (see point 4.1). An expert is a person that due to his technical training and experience has sufficient knowledge in the area of load lifting attachments and is familiar with relevant occupational and safety instructions, regulations and generally recognized codes of practice which enables him to assess operational safety of load lifting attachments.

The initial inspection of the combination hoist/OKTOPUS® as well as the successful performance of the annual inspection of the OKTOPUS® by an expert has to be documented.



The OKTOPUS® manufacturer offers expert inspections as a service and documents the inspections on the OKTOPUS® by placing the inspection tag on the inspection card according to Annex 4 with the indication of the next test date.

2.2 Safety instructions

- (1) Only employ cranes with a **Working Load Limit** that **exceeds the live weight** of the OKTOPUS® GLASS-Jack GL-LN 600 by **at least 100 kg** in all possible working positions.
- (2) **Never operate a damaged, not fully functional or incomplete OKTOPUS®!**
- (3) Prior to initial startup **have an expert check and document** the combination crane/OKTOPUS®!
- (4) Only operate the crane with an **operating license!**
- (5) Only operate OKTOPUS® and crane if you are familiar with **the control and display elements as well as the operating manuals**. You have to know how the functions affect the entire construction!
- (6) **Prior to using OKTOPUS® and crane check the function of the control and display elements as well as the warning devices!**
- (7) Ensure that the crane operator is able to overview the assembly and installation site!
- (8) Agree on **hand signals** with the technician or installer for the necessary crane movements!
- (9) It is absolutely necessary to observe the maximum Working Load Limit of the **OKTOPUS® GLASS-Jack GL-LN 600** stipulated in section **2.3 Symbols and markings!** These specifications only apply to a working height corresponding 400 m above sea level!
- (10) If the suction pads are covered by **protecting cowls**, these have to be **removed** before startup!
- (11) Only work at wind speeds **less than 30 km/h**, otherwise you risk uncontrollable swinging of the load!
- (12) **Check the suction rubbers daily for damages**; if necessary replace the suction rubbers by new ones.
- (13) **Clean the suction areas** of the glass panes. **Do not place** the suction pads on **protective foil, releasing agents** or similar, but remove it at least at the contact areas of the suction pads.
- (14) **Never stand or walk under the suspended load!**
- (15) Make sure that **nobody climbs** the OKTOPUS® GLASS-Jack GL-LN 600 or the suspended load and **tries to ride along**.
- (16) **Stop working instantly if the alarm buzzer sounds and/or the red warning light is illuminated!** In this case the system is severely damaged and there is the risk that the sucked load might drop. Carefully lower the OKTOPUS® together with the sucked load with the help of the crane until the load is securely placed. The cause of the alarm has to be found and removed. In case of unrecoverable errors all operations with the OKTOPUS® have to be discontinued immediately. The OKTOPUS® has to be secured against further use.
- (17) In case of **incidents** and maintenance work turn off the OKTOPUS®. Therefore, turn the main switch to position OFF and remove any battery charger which may be connected!
- (18) Take into consideration that **low temperatures** and **high humidity may cause freezing of the vacuum system!**
- (19) Never employ the OKTOPUS® in **explosive areas or in the area of aggressive media!**
- (20) After use, protect the suction pads of the OKTOPUS® against damage by using protection cowls!

- (21) **Never attempt to lift damaged glass or façade elements!**
- (22) **Do not suck wet elements**, because
 - a. **Working Load Limit is decreased considerably** and
 - b. the vacuum system or the control system of the OKTOPUS® could be damaged!
- (23) **Do not lift the load higher than necessary!**
- (24) **Never leave the lifted load unsupervised!**
- (25) **Always** wear suitable protective clothing, helmets, gloves and safety shoes!
- (26) **Never lift more than one glass or façade element at a time!**
- (27) Comply with the stipulated **maintenance information**:
 - **daily visual and functional inspection** (battery's charge level, vacuum gauges, suction pads, warning light, signal light, alarm buzzer, control panel)!
 - depending on the operating conditions, **but at least annually**, inspection by an expert!
- (28) Never modify the OKTOPUS® in a way that safety is impaired. **Otherwise the manufacturer's warranty will be void!**
- (29) Do not remove information signs, safety signs and inspection tags and plates from the OKTOPUS®. **Otherwise the manufacturer's warranty will be void!**

2.3 Symbols and markings

| Signal word | Meaning | Consequences of non-compliance |
|---|---------------------------------------|--|
|  | Warns of imminent threat of danger | Death or serious injury or substantial material damage as consequence. |
|  | Warns of potential threat of danger | Death or serious injury or substantial material damages are possible. |
|  | Warns of possibly dangerous situation | Light injury or material damages are possible. |

Next to the type plate the following safety-related signs and pictographs are attached to the OKTOPUS®:



(Working Load Limit OKTOPUS®)



(Before operating, read and comply with operating manual as well as safety instruction!)

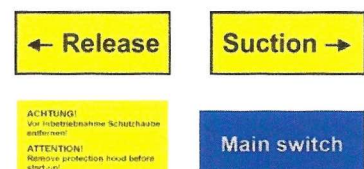

(Warning signs / General information)

Test card in accordance with Annex 4

(Inspection card)

2.4 Structure and use of the OKTOPUS®

The OKTOPUS® GLASS-Jack GL-LN 600 is a vacuum-based load lifting attachment for large-sized glass and façade elements with sufficient inherent stability and a (at least) partially smooth and airtight surface. It is designed for installation of construction elements for cladding and roofing on construction sites.

The functional main assemblies are (see fig. 1):

- the basic frame (5) with the attached suction pads (4),
- the crane arm (2) with crane eye (1) to couple the device to the crane,
- the red warning light (9) and the alarm buzzer (18), that indicate an emergency situation as well as the green signal light (19), which defines the working range,
- the charge indicator (20), that indicates the current charge level of the battery,
- the socket battery charger (10) for charging the battery,
- the vacuum gauges (13) indicating the available negative pressure,
- the rotation/swivel joint (17),
- the interlock of the tiltable crane arm (3),
- the main switch (11) in order to turn the OKTOPUS® on/off and the switch “Suction/Release“ (14) for operating the OKTOPUS®.

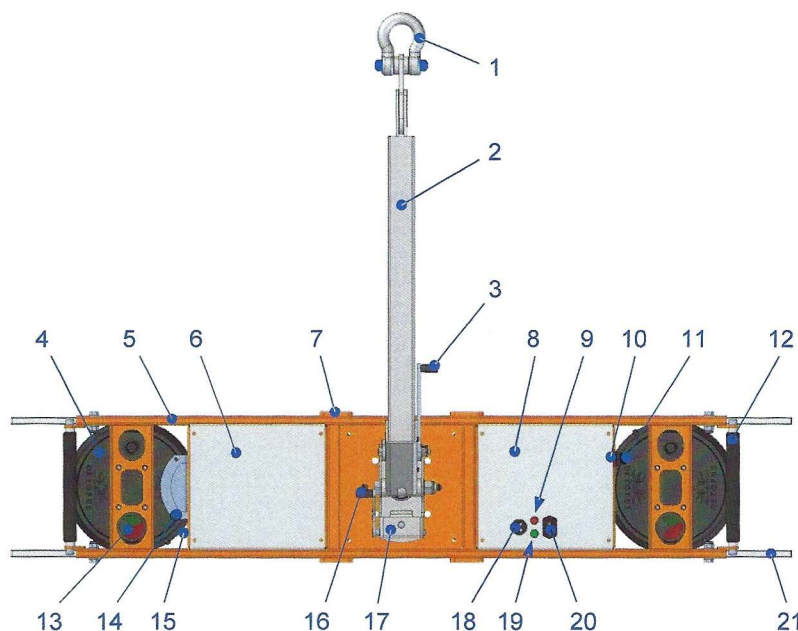

Fig. 1: OKTOPUS® GLASS-Jack GL-LN 600 basic device

| | | |
|-----------------------|-----------------------------|---------------------------------|
| 1 Crane eye (shackle) | 8 Bonnet B | 15 Button “Blow-off“ (optional) |
| 2 Crane arm | 9 Warning light red | 16 Unlocking “Rotate“ |
| 3 Unlocking “Tilting“ | 10 Socket battery charger | 17 Swivel joint |
| 4 Suction pad | 11 Main switch | 18 Alarm buzzer |
| 5 Basic frame | 12 Handle | 19 Signal light green |
| 6 Bonnet A | 13 Vacuum gauge | 20 Charge indicator |
| 7 Connecting flange | 14 Switch “Suction/Release“ | 21 Adapter plate |

The load lifting attachment OKTOPUS® GLASS-Jack GL-LN 600 is designed as an attachment and is mounted to a crane according to fig. 2.

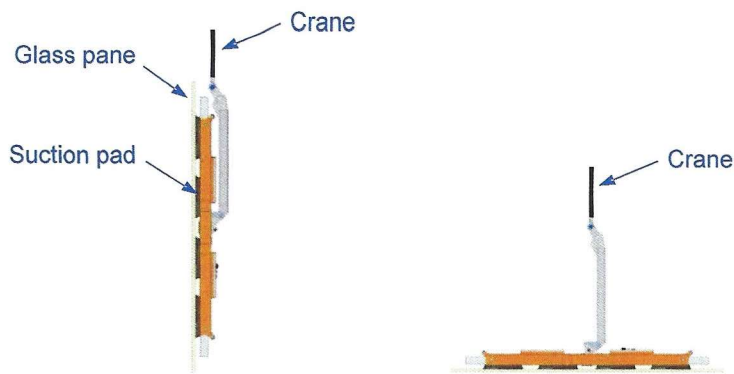
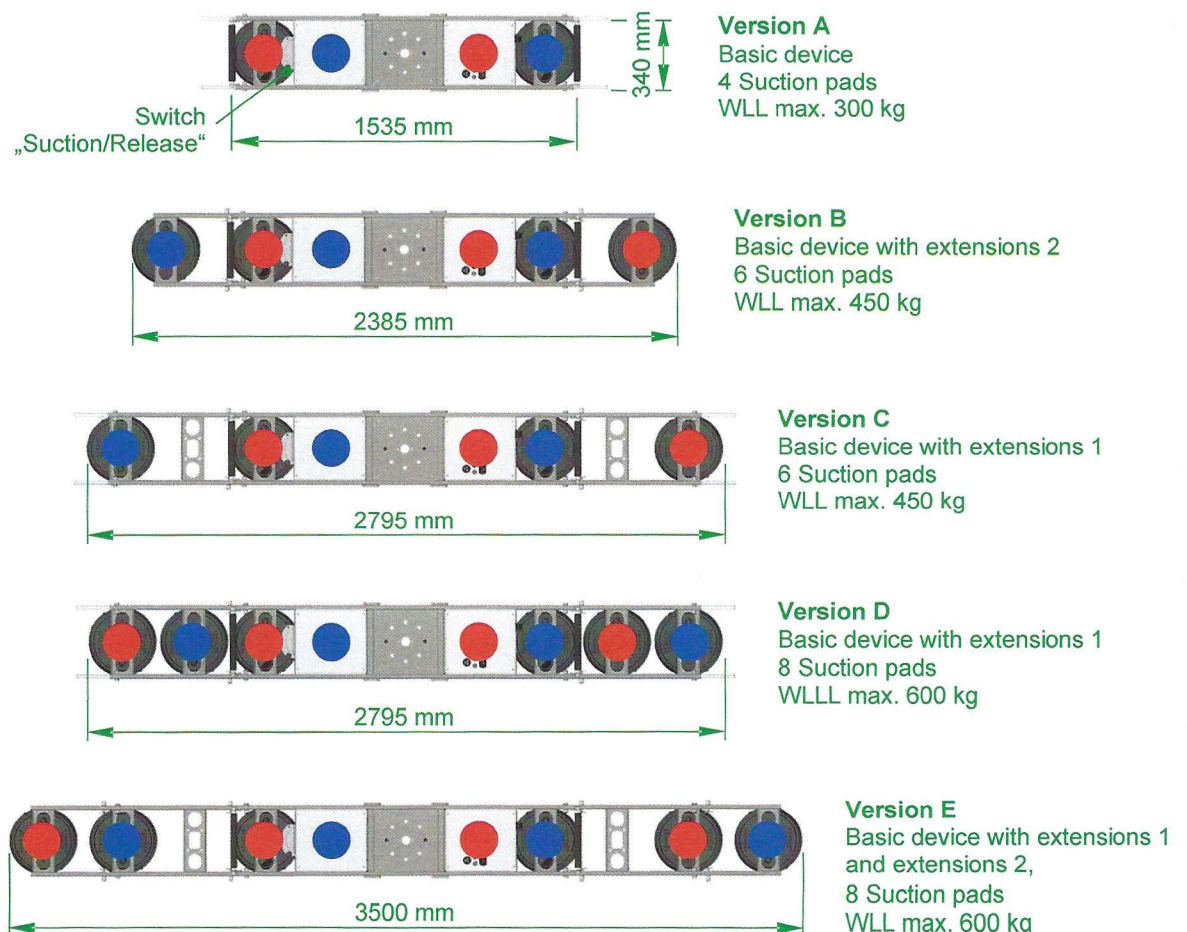

Fig. 2: Load lifting attachment OKTOPUS® GLASS-Jack GL-LN 600

2.4.1 Possible configuration of the OKTOPUS® and arrangement of the suction pads

Through the mounting of extensions (s. Point 3.3) the OKTOPUS® GLASS-Jack GL-LN 600 can be adapted to the most diverse element dimensions. All possible options can be seen in fig. 3. In order to make the presentation clearer, the crane arm is not shown.



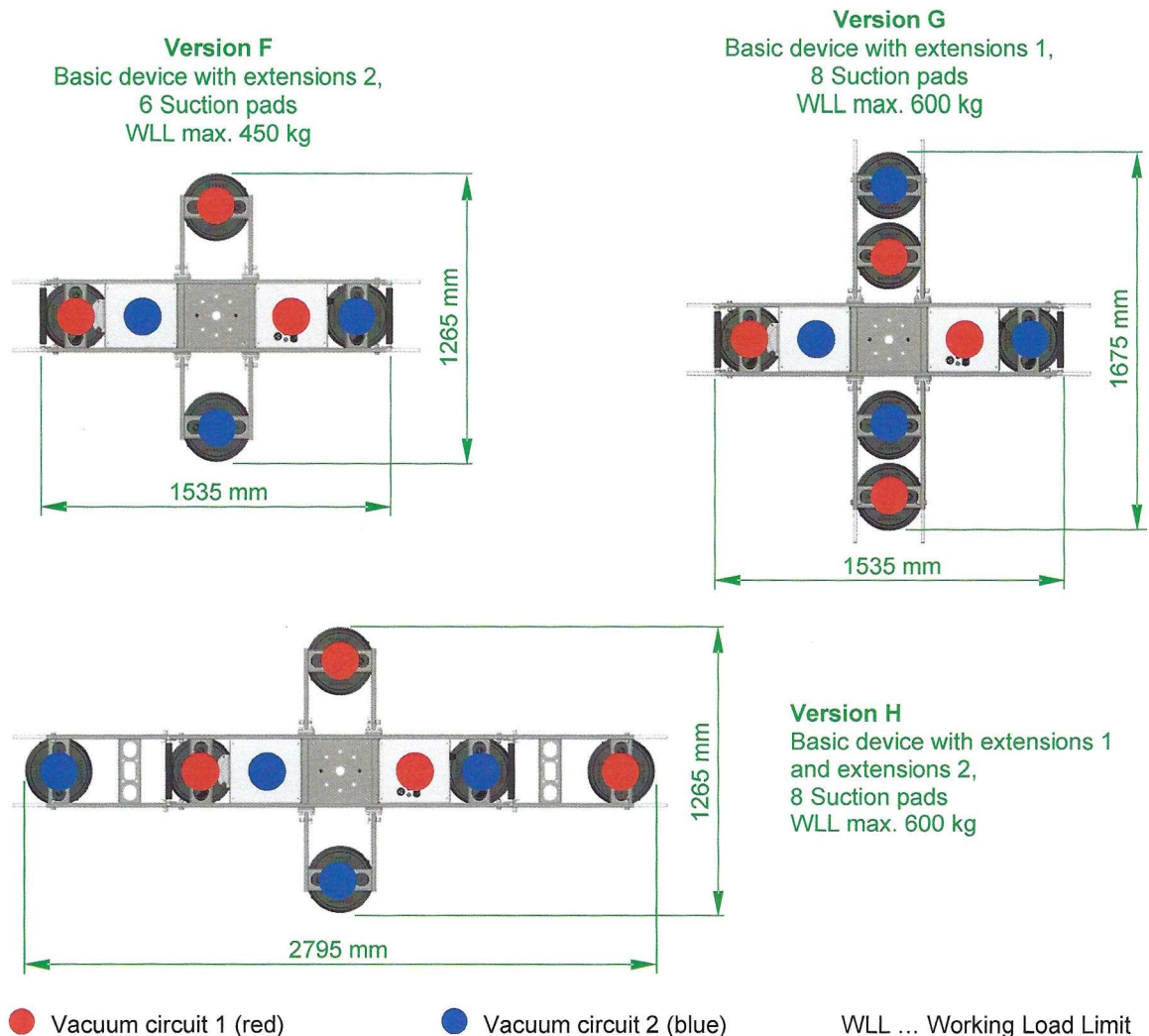

Fig. 3: Possible configuration of the OKTOPUS® and arrangement of the suction pads

When configuring the OKTOPUS®, please make sure that:

- the number of suction pads connected to the vacuum system is evenly distributed on both vacuum circles (e. g. red vacuum circle 3 suction pads and blue vacuum circle 3 suction pads).
- the suction pads connected to the vacuum system are evenly distributed on the load to be moved.

Notes:

- The four suction pads mounted to the OKTOPUS® base frame are firm parts of the basic device. Therefore, their assignment to the vacuum circles is specified.
- Please contact the Wirth service team if an arrangement of the suction pads differing from figure 3 is required.



Always distribute the suction pads evenly on both vacuum circles! Non-compliance with these instructions could, in case of a breakdown of a vacuum circuit, lead to the load suddenly dropping due to an uneven load distribution.



The less suction pads are connected to the vacuum system the lower is the Working Load Limit!

2.5 Operating conditions and restrictions

The suction areas of the glass elements to be manipulated with the OKTOPUS® GLASS-Jack GL-LN 600:

- have to be air-impermeable,
- have to have an even, dry, oil-free and clean surface and
- must not be covered with protective film!

The OKTOPUS® is delivered with suction pads for even glass panes.

Generally, no statements can be made regarding the length and the width of the elements to be installed with the OKTOPUS®, as this depends – upon observing the safe work load criteria – almost exclusively on the inherent rigidity and the correlating deformation behavior of the construction elements.

Avoid suction of oil, water, vapors or aggressive gases. Ambient temperature has to be at least 0 °C and must not exceed 40 °C (applies only to 1013 mbar and sea level). At low temperatures the capacity of the used batteries is decreased. The airborne sound emitted by the OKTOPUS® GLASS-Jack GL-LN 600 amounts to < 70 dB (A), vibrations are at < 2.5 m/s², so that no special protective measures are required.

Operating restrictions result from the limited Working Load Limit of the OKTOPUS® GLASS-Jack GL-LN 600 (see section 2.3 Symbols and markings) as well as the performance data, the operating conditions of the used crane and the building site conditions. Furthermore, you have to regard the fact that the manipulated elements have to have sufficient inherent stability and are suitable to be installed with a vacuum lifting attachment (if necessary consult with the manufacturer of the elements).

Due to the broad variety of elements with many different surface coatings offered on the market we cannot assume liability in case of possible material incompatibilities between suction rubber and surface coating.

The maximum Working Load Limit stipulated on the OKTOPUS® only applies to the use of the original suction pads and a working height of maximum 400 m above sea level. Employing the OKTOPUS® in heights above 400 m leads to a decreased Working Load Limit of the OKTOPUS® on the one hand, on the other hand the OKTOPUS® control system needs to be adjusted. If you want to employ the OKTOPUS® in heights above 400 m, please contact the Wirth Service Team beforehand.



Employing the OKTOPUS® at heights above 400 m leads to a decreased Working Load Limit! The Working Load Limits stipulated on the OKTOPUS® and in this operating manual do not apply in this case!



Never carry out unauthorized adjustments at the control system of the OKTOPUS® as it may lead to serious malfunctions of the device! It means danger to life and limb! Consult with the OKTOPUS® manufacturer if it is necessary to adjust the control system of the OKTOPUS®, e.g. for height adjustment.

2.6 Transport and storage

The OKTOPUS® may be moved only by a suitable hoisting device/means of transport of appropriate Working Load Limit.



For transport purposes put the OKTOPUS® out of operation! Turn the main switch to position OFF!



Protect the rubber lip of the suction pads with protective cowls from dirt and damage!



Preserve the OKTOPUS® if needed, in order to avoid damages to the lifting attachment during long-term storage.



In order to avoid damage due to deep discharge of the batteries during storage, the OKTOPUS® has to be charged at least every two weeks.

3 Instructions for using the OKTOPUS®

3.1 Electrical power supply

Electrical power is supplied by a battery 24 V / 7 Ah (2 pcs. 12-V batteries in series connection).

The battery charge level is controlled by a charge indicator according to figure 4. After switching on the OKTOPUS®, light-emitting diodes (LED) in the signal colours green, yellow and red indicate the current charging level.

The charge indicator can show the following charging levels:

- ⇒ If one of the green LED lights up, the battery is charged, so the OKTOPUS® is ready for use.
- ⇒ If the third LED from the left (yellow LED) lights up, the battery should be charged.
- ⇒ If the second LED from the left (yellow LED) lights up, or if the second LED from the left and the red LED light up in turns, the battery has to be charged without delay, in order to avoid deep discharge and potential damages.

The charge indicator is arranged on the unit as per fig. 1.

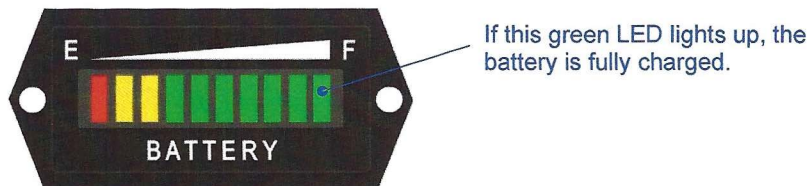

Fig. 4: Charge indicator



Do not use the OKTOPUS®, if the yellow LED is flashing, or the yellow and the red LED are flashing alternately. Possibly sucked loads shall be lowered. The OKTOPUS® has to be charged instantly in order to avoid deep discharge and by that possible damage to the battery.



The user has to ensure that the battery is properly charged when operating the OKTOPUS®.



The charge indicator only indicates the current voltage level of the battery. It does not give any reliable information regarding the battery's capacity.



The charge indicator responds rather slowly. In order to assess the voltage level realistically after the charging process (see point 4.4) you have to run the vacuum pump of the device for approximately 2 minutes, and then use the indicated charge level of the battery as a basis for assessing how to employ the device.

3.2 Vacuum supply

The vacuum supply is effected by an electrical operated vacuum pump that is powered by the battery. Starting at the vacuum pump the OKTOPUS® GLASS-Jack GL-LN 600 is designed as a dual circuit system. That means that all the following vacuum components such as non-return valve, vacuum reservoir, pressure controller, vacuum gauge and suction pads exist twice (two vacuum circuits).

The two vacuum circuits of the OKTOPUS® GLASS-Jack GL-LN 600 are marked by different colors, one color per vacuum circuit (blue and red). You have to ensure that suction pads with vacuum hoses of the same color are always arranged diagonally to each other at the suction frame.

The OKTOPUS® GLASS-Jack GL-LN 600 mounted to the crane is ready for use, when a sufficient vacuum level is reached in both vacuum tanks. The current vacuum level is constantly indicated on the vacuum gauges (figure 5).

The green scale range is the

permissible working range from -0.65 bar to -0.9 bar.

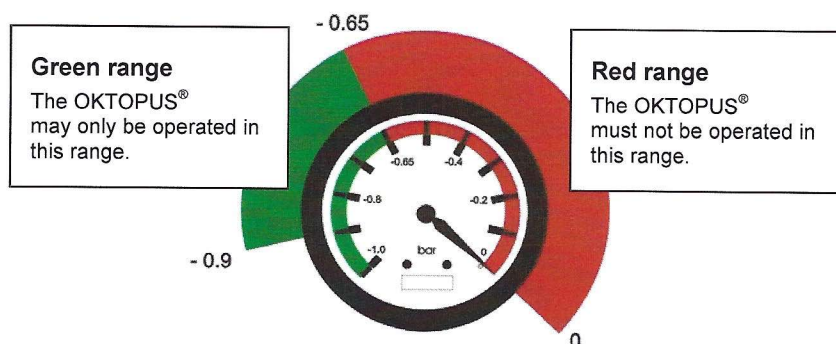

Fig. 5: Vacuum gauge

During operation the vacuum is monitored by two pressure controllers. If the vacuum is in the working range in both vacuum circuits, the OKTOPUS® is ready for use.

If the vacuum decreases impermissibly in one or both vacuum circuits or the pressure rises above -0.65 bar (red scale range) a warning is triggered automatically:

- ⇒ the alarm buzzer sounds,
- ⇒ the red warning light flashes.



Only interconnect vacuum hoses and couplings of the same color! Non-compliance with these instructions could, in case of a breakdown of a vacuum circuit, lead to the load suddenly dropping due to uneven load distribution.



If the alarm is activated, stop working instantly and evacuate the hazard zone, as the sucked element could disengage suddenly. Never stand or walk under the OKTOPUS® or the suctioned element!



The alarm remains active until the vacuum pressure is restored within its permitted limits.

3.3 Preparation of the OKTOPUS®

The OKTOPUS® GLASS-Jack GL-LN 600 is of modular construction. The OKTOPUS® can be ideally adapted to the size of the elements to be handled by adding optional extensions and by modifying the suction pads (please also refer to pt. 2.4.1)

3.3.1 Assembling and disassembling of the extensions

The **assembly** of the extensions is performed as follows:

1. Connect the OKTOPUS® to a crane, lift it slightly and align the suction pads so that they are oriented downwards.
2. Push the extension to be mounted up against the adapter plates and/or the connecting adapter.
3. Fix the extensions with two locking bolts. Secure both locking bolts with one lynch pin each.
4. Connect the suction pad(s) of the extension to the OKTOPUS® vacuum system by inserting the quick disconnect. Please note the explanations under point 2.4.1.

The **Disassembly** is performed in reverse order.

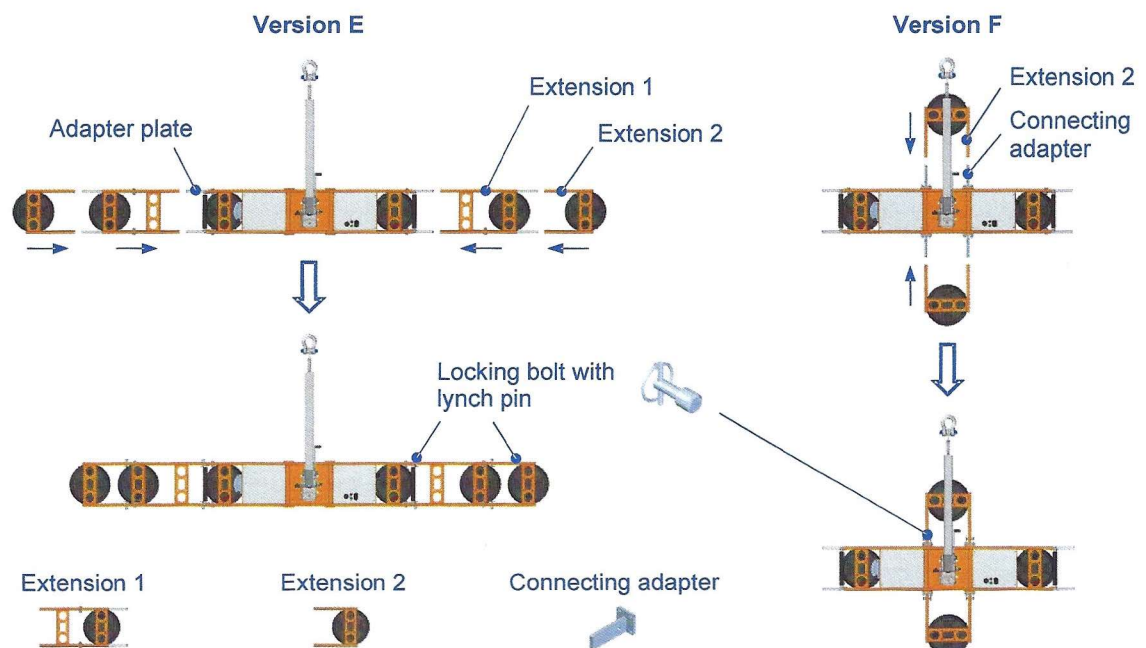

Fig. 6: Mounting of the extensions (Examples)

Notes:

- In order to be able to connect the extensions sideways onto the basic device (e.g. version F), the four connecting adapters must be mounted. For the assembling of the connecting adapters use the hexagon screws M10, washers and spring washers that are included in the delivery.
- Always assemble/disassemble the extensions in pairs (please refer to pt. 2.4.1).



Only use the OKTOPUS® if the extensions are completely fixed to the connectors included in the delivery!

3.3.2 Modification of suction pads

In order to realize the OKTOPUS® configuration version D and G (see fig. 3) it's necessary to mount a second suction pad onto each of the extensions 1. Therefore proceed as follows:

1. Disassemble the suction pads from the extensions 2 by loosening the four Allen screws M8.
2. Mount a second suction pad onto each of the extensions 1. Therefore use the previously removed Allen screws M8.

3.3.3 Adjustment of the crane eye

The incline of the crane eye is adjusted as follows:

1. Remove the locking bolt with lynch pin (see fig. 6).
2. Turn the crane eye to the required position.
3. Secure the crane eye with the previously removed locking bolt and the lynch pin.



Pay attention that the crane eye is always completely secured with the locking bolt and lynch pin included in the delivery!

3.4 Control panel / switch

The OKTOPUS® GLASS-Jack GL-LN 600 is operated on the device according to fig. 7.

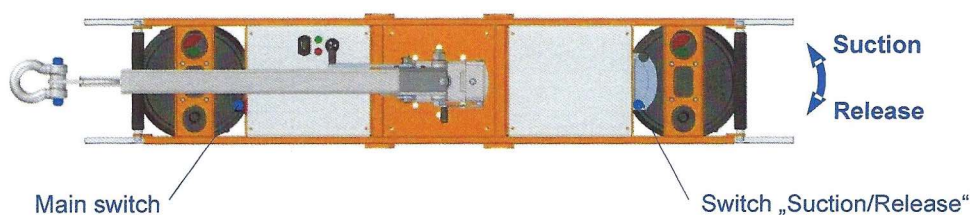

Fig. 7: Switch „Suction/Release“

3.5 Startup

In order to startup the OKTOPUS® proceed as follows:

- Place the suction pads of the OKTOPUS® on the element to be suctioned!
- Turn the main switch to position „ON“!
- Slightly lift the switch “Suction/Release” and slide it towards “Suction”!
- Check the battery charging status on the charge indicator:
 - ⇒ A green LED flashing up shows readiness of operation,

- ⇒ If the second LED from the left (yellow LED) lights up or the second LED from the left (yellow LED) and the red LED light up in turns, the battery needs to be charged!
- Check the vacuum level on the vacuum gauges:
 - ⇒ If the indicators of both gauges are in the green range, the unit is ready for operation!
 - ⇒ If there are one or both indicators in the red range, the alarm will be active. Vacuum has to be built up.
 - Vacuum is built up till -0.73 bar, the red warning light switches off, the green signal light turns on.

3.6 Handling of glass and cladding elements

Prior to attaching of glass and cladding elements the OKTOPUS® needs to be:

- ⇒ connected to the crane as load lifting attachment.
- ⇒ configured according to the load to be handled (mount extensions if necessary).
- ⇒ started up as described in paragraph 3.5.

3.6.1 Handling of lying glass and cladding elements

- ⇒ Remove the unlocking „Tilting“ (see Fig. 8) and move the crane with the OKTOPUS® GLASS-Jack GL-LN 600 towards the elements. Place the OKTOPUS® onto the topmost element.



To avoid unintended load rotations, make sure that the unlocking lever “Rotate” (see fig. 7) is latched. The unlocking lever “Tilting” has to be released and the crane arm to be upright!



Never try to lift a horizontally lying load, if the tilting movement of the crane arm is locked!



- ⇒ Place the OKTOPUS® above the load centre of mass (± 5 cm).



Make sure the load is properly placed at the OKTOPUS®! Unbalanced loads can provoke unexpected tilting or rotating movements!

- ⇒ Now the suction of the construction element is performed. Therefore slightly lift the switch “Suction/Release” (see fig. 7), and then shift it towards “Suction” until it latches (see also pt. 3.5 “Start-up”).
- ⇒ After the red warning light and the alarm buzzer have gone out, the vacuum gauges indicate that the working range (see fig. 5) has been reached, the green signal light flashes and you’ve made sure that there’s nobody in the hazardous area, you can lift the load.
- ⇒ Only lift the load as high as necessary!
- ⇒ Completely fix the element after mounting it to the assembly site!
- ⇒ After that the construction element is released. Again slightly lift the switch “Suction/Release” for releasing and shift it towards “Release”. Lifting the switch means an additional security against unintended maloperation.

If your OKTOPUS® is equipped with the optional blow-off function, subsequently press the button "Blow-off" (see fig 1, Pos. 15). Keep the button pressed until all suction pads have completely disengaged from the load. In this case compressed air is applied to the suction pads which ensures that the suction pads are released quicker from the load.



Due to the dead weight of the OKTOPUS®, a residual vacuum even remains after ventilating the suction pads by the vacuum system. Jerky rising of the OKTOPUS® strengthens this effect. Therefore, always take the equipment slowly and steadily off the laid elements.

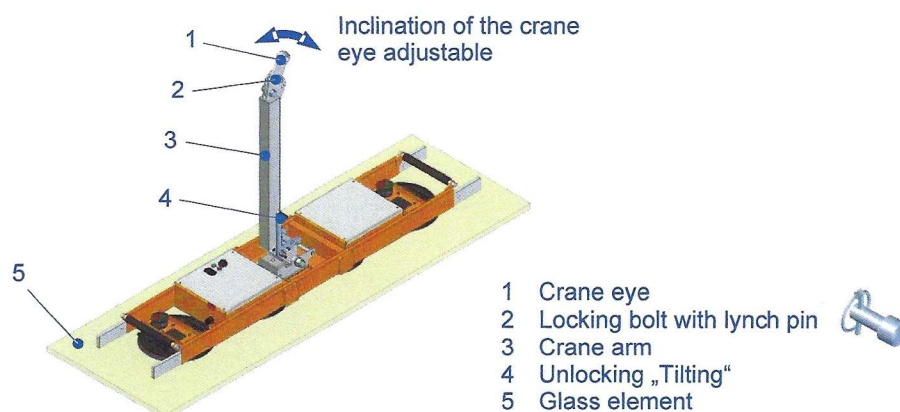

Fig. 8: OKTOPUS® GLASS-Jack GL-LN 600 with horizontal glass element

3.6.2 Handling of upright glass and cladding elements.

- ⇒ Move the crane with the mounted OKTOPUS® GLASS-Jack GL-LN 600 towards the elements. Place the OKTOPUS® onto the topmost element.
- ⇒ Place the OKTOPUS® onto or above the load centre of mass (max. ±5 cm).



To avoid unintended load rotation or tilting, make sure that the unlocking levers (see fig. 9) are latched!

- ⇒ Now the suction of the construction element is performed. Therefor slightly lift the switch "Suction/Release" (see fig. 7), and then shift it towards "Suction" until it latches (also see pt. 3.5 "Startup").
- ⇒ After the red warning light and the alarm buzzer have gone out, the vacuum gauges indicates that the working range (see fig. 5) has been reached, the green signal light flashes and you've made sure that there's nobody in the hazardous area, you can lift the load.
- ⇒ Only lift the load as high as necessary!
- ⇒ Completely fix the element after mounting it to the assembly site!
- ⇒ After that the construction element is released. Again slightly lift the switch "Suction/Release" for releasing and shift it towards "Release". Lifting the switch means an additional security against unintended maloperation.

If your OKTOPUS® is equipped with the optional blow-off function, subsequently press the button "Blow-off" (see fig 1, Pos. 15). Keep the button pressed until all suction pads have completely disengaged from the load. In this case compressed air is applied to the suction pads are which ensures that the suction pads are released quicker from the load.



Due to the dead weight of the OKTOPUS®, a residual vacuum even remains after ventilating the suction pads by the evacuated system. Jerky rising of the OKTOPUS® strengthens this effect. Therefore, always take the equipment slowly and steadily off the laid elements.

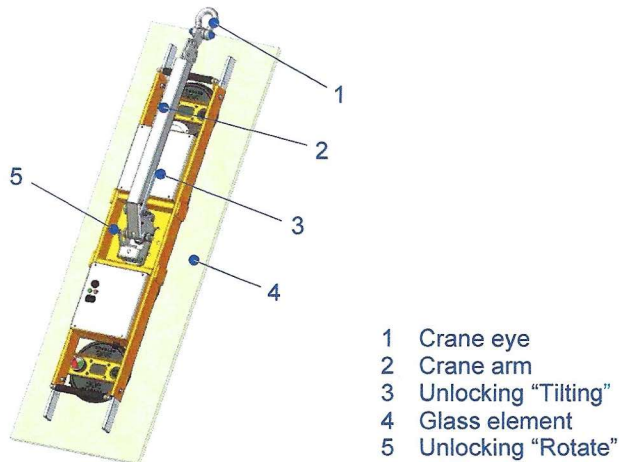

- 1 Crane eye
- 2 Crane arm
- 3 Unlocking "Tilting"
- 4 Glass element
- 5 Unlocking "Rotate"

Fig. 9: OKTOPUS® GLASS-Jack GL-LN 600 with vertical glass element

3.6.3 Rotating vertically hanging loads

⇒ Perform suction of the element as described in 3.5.2!



Never release the unlockings "Rotating" and "Tilting" at the same time! Releasing both unlockings can provoke damages to the device and/or the load!

- ⇒ Before rotating the load, make sure that there is enough space. Ensure that the load cannot strike against anything during rotation!
- ⇒ Release the unlocking "Rotation" (see fig. 9) and rotate the load to the required position. After that latch the unlocking handle.

3.6.4 Tilting vertically hanging loads

⇒ Perform suction of the element as described in 3.5.2!



Never release the unlocking "Tilting" when it is under load! This would cause uncontrolled "downward tilting" of the load!



In order to tilt the load from vertical to horizontal position, there are at least three persons required. Two persons to secure the load and the third person to activate the unlocking!

- ⇒ Before tilting the load, please note that the tilted load requires more horizontal space. Ensure that the load cannot strike against anything during tilting.
- ⇒ Release the unlocking "Tilting" (see fig. 9) and position the load horizontally.

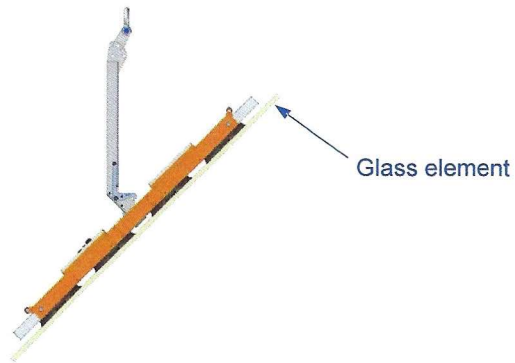

Fig. 10: OKTOPUS® GLASS-Jack GL-LN 600 during tilting

4 Service and Maintenance

4.1 General remarks

Since the OKTOPUS® system is a load lifting attachment both the manufacturer and the operator carry a high responsibility to guarantee the relevant safety standard throughout the entire operating time. Thus, service and maintenance are of great importance.

For maintaining a high level of operational safety the OKTOPUS® GLASS-Jack GL-LN 600 has to be inspected by the service workshop of Wirth GmbH or by an especially qualified person

- ⇒ at least every 12 months or in shorter intervals, if required by national standards or regulations or
- ⇒ after special incidents.

Additional operative and scheduled maintenance and service work may only be performed by a skilled expert. Maintenance and service work may only be performed when the device is taken out of operation.



Before performing any repair and maintenance work switch off the OKTOPUS®; slightly lift the switch “Suction/Release” and slide it towards “Release”.

Defective parts may only be replaced with original spare parts. They will be provided on request after consulting with the service team of the OKTOPUS® manufacturer. Using not original spare parts leads to exemption from liability by the manufacturer.

In order to perform maintenance and service work an appropriate tool kit has to be used.



Maintenance has always to be followed by a functional check.

If damages cannot be repaired by the operator's staff the Wirth GmbH service workshop needs to be informed.

4.2 Mechanical system

The mechanical system is sturdy and provided with a surface protection. Maintenance works on your side comprise

- ⇒ **daily visual inspection of the mechanical components of the OKTOPUS® GLASS-Jack GL-LN 600** for damages before startup.

The OKTOPUS® GLASS-Jack GL-LN 600 is a load lifting attachment. Therefore, repairs on the mechanical function parts shall exclusively be carried out by the OKTOPUS® manufacturer.



Do not perform any repairs at mechanical functioning parts!

4.3 Vacuum system

Vacuum components, subjected to wear and being relevant to safety have to undergo inspections on a regular basis. You have to:

- ⇒ **daily** check the components in terms of their correct position and mechanical damages, especially:
- the suction pads (if necessary, replace suction pads),
 - the hoses (if necessary, replace hoses),
 - the vacuum gauges.



Replace the suction pads and the hoses immediately if these have mechanical damages (cracks, cuts, etc.)! These damages could lead to a reduced Working Load Limit of the OKTOPUS®.

The vacuum pump runs without oil. The robust design allows a maintenance-free operation. A filter that prevents dust to enter the vacuum pump is integral to each suction pad. Therefore, maintenance of the vacuum systems is focused on this part:

- ⇒ Slightly lift the OKTOPUS® without load. The filter is located in the passage to the connector of the vacuum line. Remove all dirt from the filter if it is polluted.

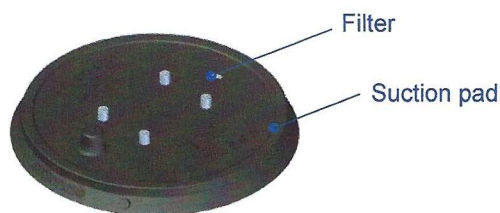

Fig. 11: Suction pad

4.3.1 Cleaning the suction pads

Always clean the suction pads prior to every operation of the OKTOPUS®, if the suction areas are soiled (dirt, dust, oil, etc.). Dirt could cause leakages and leave marks on the manipulated elements.

For cleaning the suction pads we recommend to use water, if necessary add some detergent. Do not use chemical solvents, petrol, diesel oil or similar in any case.



Never use solvents, petrol or aggressive chemicals for cleaning the suction pads! Otherwise this may result in damaging the suction pads, which could endanger the operator as well as others.

Ensure that fluids cannot enter the vacuum system during the cleaning process by positioning the suction pads or by covering the suction opening. Give the suction pads a sufficient amount of time to completely dry before operating the OKTOPUS®.

4.4 Electrical and electronic components

The OKTOPUS® GLASS-Jack GL-LN 600 is powered by two maintenance-free lead-batteries with acid-gel as electrolyte. The battery casings are sealed hermetically.

Maintenance work focusses on:

- ⇒ **daily** visual inspection of the external electrical functional and alarming equipment:
 - warning light,
 - signal light,
 - alarm buzzer.
- ⇒ visual inspection of the battery's charge level shown on the charge indicator (see figure 4).
- ⇒ charging the battery

For charging purposes a charging unit 24 V / 5 A is provided by the OKTOPUS® manufacturer (see figure 13).

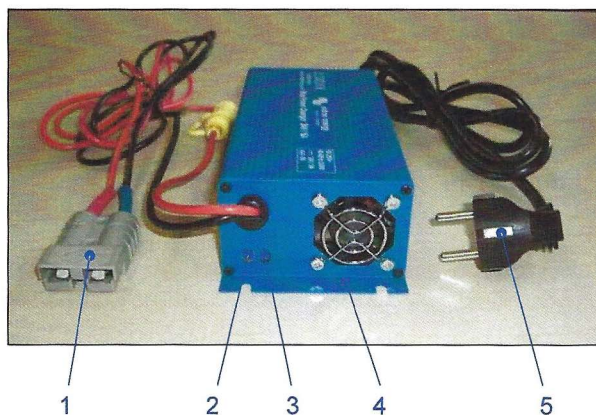

- 1 Charging plug
- 2 Yellow LED
- 3 Green LED
- 4 Battery charger
- 5 Power plug

Fig. 12: Battery charger (sample)



Before connecting the battery charger check if it is compatible to your power grid! The performance data are stipulated on the battery charger.



If you want to use a battery charger other than the one provided with the OKTOPUS®, it is absolutely necessary to contact the Wirth Service Team beforehand!

The charging process is operated as follows:

- Turn off the OKTOPUS® by turning the main switch to position “OFF”!
- Connect the charge plug of the charging unit with the battery charger socket of the OKTOPUS®.
- Connect the mains plug of the charging unit to a socket and by that to the power grid to start the charging process.
- The charging process is completed when the yellow LED is permanently illuminated.
- In order to disconnect the charging unit from the OKTOPUS® proceed as follows:
 1. Disconnect the charging unit from the power grid,
 2. Disconnect the charging unit from the battery.

LED display

- ⇒ The green LED is illuminated if the battery charger is connected to the power grid.
- ⇒ The yellow LED flashes quickly during the first charging phase and slower during the second. At the end of the charging cycle the yellow LED is permanently illuminated.

For maintenance and in case of breakdown of the charging unit please contact our Service Team.



The sealed lead-gel battery requires strict adherence to the charging instructions!



In order to avoid damage due to deep discharge the batteries of the OKTOPUS® have to be charged at least every two weeks.



The battery charger has to be protected from spray water and has to be set up in a way that the air vents and the fan are unobstructed and cannot be pierced through by pointed objects.

5 Handling incidents

Incidents are indicated by the red warning light and the sound of the alarm buzzer. A fading sound of the alarm buzzer signals total breakdown of electrical power supply.

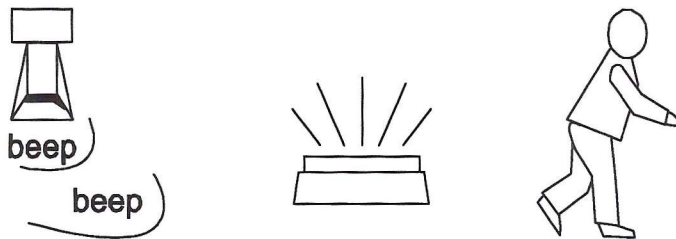

Fig. 13: Warning devices

When the alarm buzzer sounds and/or the red warning light flashes immediately leave the danger area, since the sucked element might suddenly drop. Locate and eradicate the cause for the alarm. If you cannot remedy the fault, stop operating the OKTOPUS® immediately. After releasing a possibly sucked element the OKTOPUS® has to be secured against further use.



In case of faults that cannot be remedied, working with the OKTOPUS® shall be stopped immediately. The OKTOPUS® has to be secured against further use.

If the display of the charge indicator is not illuminated when turning on the OKTOPUS® please contact the Wirth GmbH Service Team immediately.

6 Disposal and recycling

For packaging the OKTOPUS® materials like wood, cardboard, paper and film are used. These materials shall be recycled according to national regulations.

To dispose the OKTOPUS® hand it over to a waste management company. If you have any question, please do not hesitate to contact Wirth GmbH.



For environmental reasons, hand over the OKTOPUS® for disposal to a waste management company being fully aware and observing the respective national regulations!

Abstract of Operating Instructions OKTOPUS® GLASS-Jack GL-LN 600

1 Preparation of the OKTOPUS®

- (1) Fix the OKTOPUS® to the crane hook.

2 Start-up of the OKTOPUS®

- (1) Place the OKTOPUS® onto the construction element to be sucked.
- (2) Turn the main switch to position „ON“.
- (3) Slightly lift the switch „Suction/Release“ and shift it towards „Suction“ until it latches.
- (4) Check the charging status of the battery at the charge indicator:
 - The flash of a green LED indicates readiness of operation.
 - If the third LED from the left (yellow LED) lights up, the battery should be charged.
 - If the second LED from the left (yellow LED) flashes or the second LED from the left (yellow LED) and the red LED light up in turns, the battery has to be charged.
- (5) Check the vacuum pressure at the vacuum gauges (permissible green range -0.65 till -0.9 bar):
 - If the pressure indication in one or both gauges is in the red range, the alarm will be activated and vacuum needs to be built up.
 - If the pressure in both vacuum gauges is indicated in the green range, then the OKTOPUS® is ready for operation, the red warning light switches off, the green signal lamp switches on.

3 Instruction for use

- (1) Preparation of the element:
 - Check the element surface: The surface shall be smooth, airtight, clean and dry at least at the suction spots. There must not be any protection film in the area of the suction spots.
- (2) Lifting the element:
 - Place the OKTOPUS® onto the element.
 - Slightly lift the switch „Suction/Release“ and shift it towards „Suction“ until it latches.
 - After the red warning light and the buzzer turned off, the vacuum gauges indicate that the working level has been reached, the green signal lamp lights up and you have made sure that there is nobody in the hazard area, you can lift the load.
- (3) Element positioning:
 - Lift/erect the element by lifting movement of the crane.
 - Positioning of the element by driving and lifting movements of the crane with manual guidance by the installer at the same time.
 - Fix the element to the place of installation.
- (4) Detach the OKTOPUS® from the element:
 - Slightly lift the switch „Suction/Release“ and shift it towards „Release“ until it latches.

4 Shut-down

- Lower the crane and disconnect the OKTOPUS® from the crane, turn the main switch of the OKTOPUS® to position „OFF“.
- In case of shut-down for a longer period, the batteries of the OKTOPUS® shall be charged at least every 2 weeks.

Functional dimensions

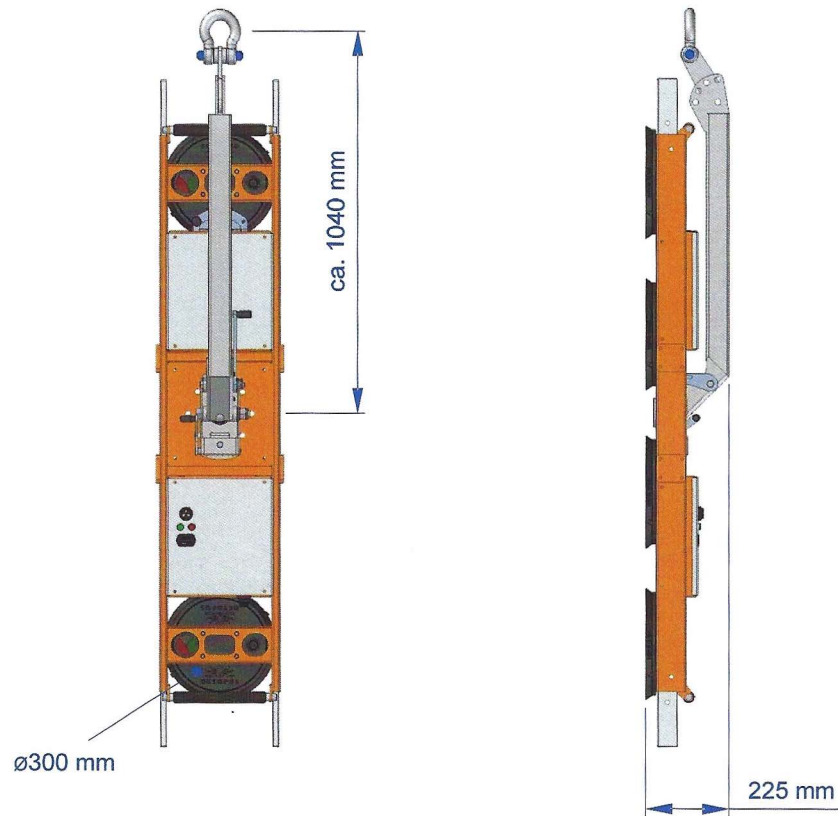

Please refer to Fig. 3 of the Operation Instructions for any further functional dimensions of the OKTOPUS® GLASS-Jack GL-LN 600.

Declaration of Conformity

Pursuant to Appendix II A of the EU machinery directive 2006/42/EC

Manufacturer: WIRTH GMBH
Installation Systems Division
Brehnaer Straße 1
D-06188 Landsberg
Germany

Herewith we declare that the machine hereinafter described is in conformity with any provisions relevant to the EC machinery directive 2006/42/EC:

Product description: OKTOPUS® GLASS-Jack GL-LN 600
Type: OKTOPUS® GLASS-Jack GL-LN 600 R M B24 P 110
Serial number: *A 810 664*
Year of manufacture: *04/2017*

Furthermore, the machine corresponds with the requirements of **EC-Directive 2009/104/EC concerning the minimum safety and health requirements for the use of work equipment by workers at work**, of **EC-Directive 2001/95/EC on general product safety** and of **EC-Directive 2014/30/EU on electromagnetic compatibility**.

Applied harmonized standards:

DIN EN ISO 12100 (03/11)

Safety of Machinery – General Principles for Design – Risk Assessment and Risk Reduction

DIN EN ISO 13857 (06/08)

Safety of Machinery – Safety distances to prevent hazard zones being reached by upper and lower limbs

DIN EN 60204 Part 1 (06/07)

Electrical equipment of machines – Part 1: General Requirements

DIN EN 13155 (08/09)

Cranes - Safety - Non-fixed Load Lifting Attachments

Authorized representative for compiling the relevant technical documents:

Sven Röthe, Brehnaer Straße 1, D-06188 Landsberg

This declaration solely corresponds to the machine in the status as put on the market, any parts additionally installed and/or modifications additionally carried out by the end user shall be unconsidered. This declaration shall become invalid, in case the product should be modified without our approval.

Landsberg, *10.04.2017*

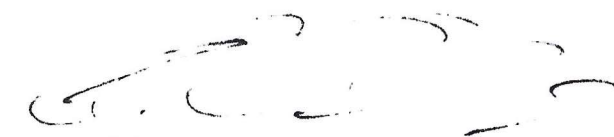

Holger Schadwinkel
(Managing Director)

Inspection Tag of the OKTOPUS® GLASS-Jack GL-LN 600

Pursuant to EC directive 2006/42/EG

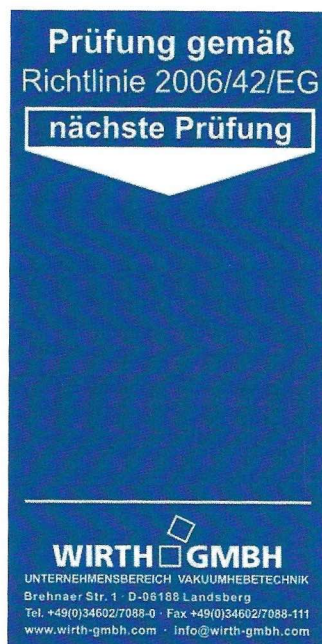

Label dimensions: 80 x 40 mm

Background: blue

Foreground: white

Script: white on blue

Badge size: Diameter 30 mm

Background: depending on the year

Foreground: depending on the year

Electrical Circuit Diagram

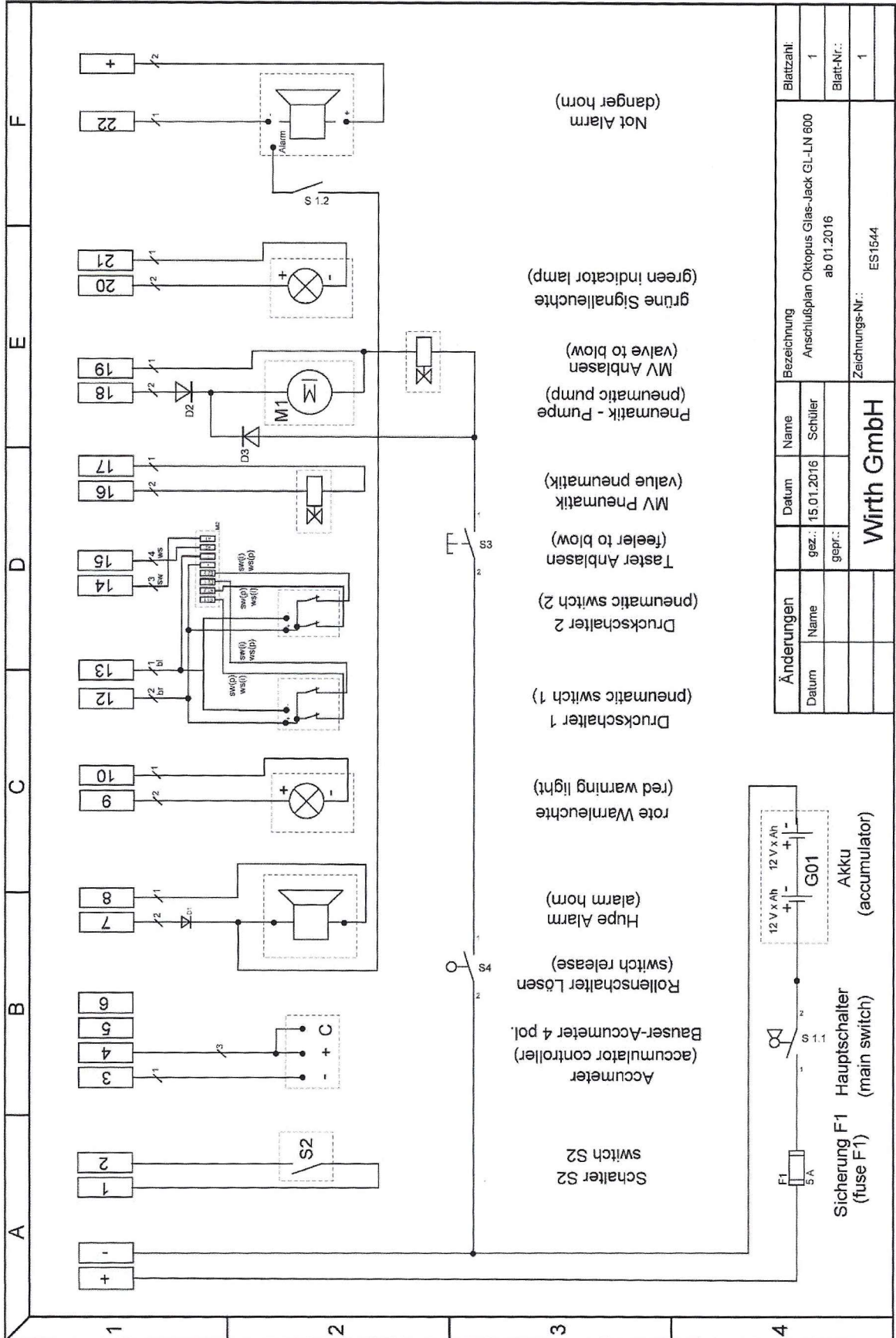

| Änderungen | | Name | | Datum | | Bezeichnung | | Blattzahl: | |
|-------------------|------|-------|--------|------------|---------|--|--|------------|---|
| Datum | Name | gez.: | gepr.: | 15.01.2016 | Schüler | Anschlußplan Oktopus Glas-Jack GL-LN 600 ab 01.2016 | | 1 | 1 |
| | | | | | | Zeichnungs-Nr.: ES1544 | | | |
| Wirth GmbH | | | | | | | | | |